



**COMPAQ**



5 1 7 2 1 2 - 8 0 1

Printed in

## **Upgrading and Servicing Guide**







**COMPAQ**

## **Removing and Replacing the Hard Disk Drive**



Features may vary by model.



---

# Removing and Replacing the Hard Disk Drive



20 to 40 minutes

---

## Before You Begin

After you replace the hard disk drive, you have to perform a system recovery. Refer to the documentation that came with your computer for detailed system recovery steps.

---

**IMPORTANT:** A hard drive is extremely sensitive to shock impact. Do not bang or drop it. Do not touch the circuit board. Static electricity can damage the drive.

---

Observe the following requirements before removing and replacing a hard disk drive.



### Tools Needed

- Flathead screwdriver

Hewlett-Packard recommends using a magnetic tipped screwdriver. You can use a flathead screwdriver with the following screw.



**CAUTION:** This product contains components that are easily damaged by electrostatic discharge (ESD). To reduce the chance of ESD damage, work over a noncarpeted floor. If possible, ground yourself while touching the metal frame of the computer, prior to handling components.

---

**IMPORTANT:** Treat an optical disc drive with care. It is easy to damage. It is sensitive to shock impact. Do not bang or drop it.

---

---

### WARNING:



- 1 **Never open the cover with the power cord attached or power applied. You may damage your computer or be injured from the spinning fan blades.**
  - 2 **Avoid touching sharp edges inside the computer.**
- 

**NOTE:** Computer features may vary by model.

---

## Removing the Hard Disk Drive

- 1 Remove all removable media such as CDs or DVDs from the computer.
- 2 Turn off the computer using the shutdown procedure for your operating system.
- 3 Disconnect the power from the wall and from the back of the computer.

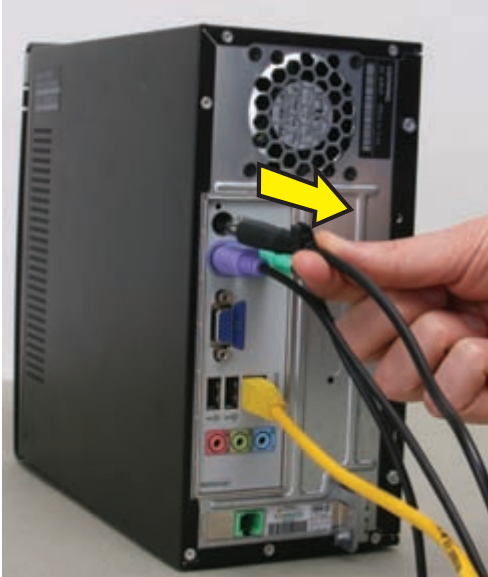

- 4 Turn off all peripheral devices (such as monitor, printer, and external drives) and disconnect them from the computer.
- 5 Disconnect the mouse, keyboard, ethernet cable, and/or phone line.
- 6 Remove the two screws that fasten the left side panel to the computer.



- 7 Slide the left side panel about 1.27 cm (0.5 in) toward the rear of the computer.



- 8 Pull the panel away from the computer and set it aside.



- 9 Release the two latching tabs on the left side of the front bezel by pulling them slightly outward. When the left side of the front bezel is released, pull it away from the computer.

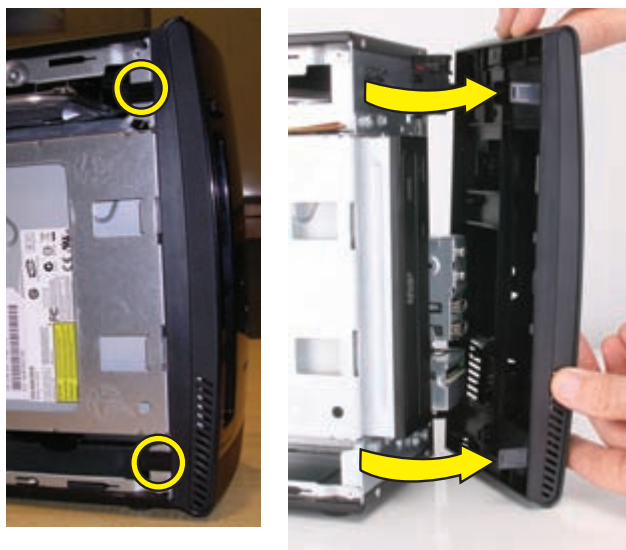

- 10 Spread a towel or soft cloth on your working surface. Then lay the computer on its side, with the open side up.

---

**NOTE:** You must remove the optical drive before you can remove the hard drive.

---

- 11 Remove the two screws that secure the optical drive cage to the front of the computer.



- 12 Lift the front edge of the optical drive and cage assembly (1), and then slide the tabs (2) out of the notches at the rear of the computer.

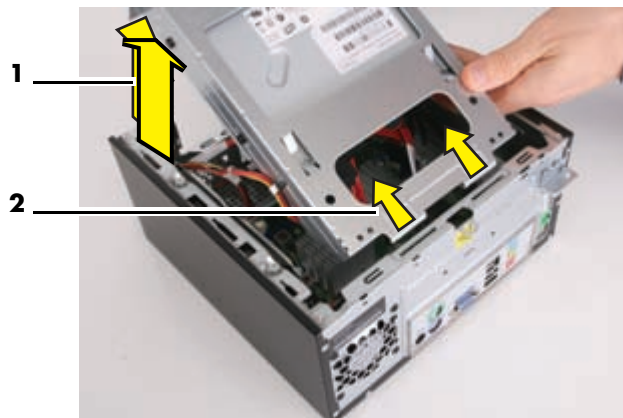

- 13 Disconnect the power cable and data cable from the back of the optical drive.

Press the release button on the end of the power cable and the data cable while disconnecting these cables from the drive.

---

**NOTE:** The location of the cable connections may vary with the optical drive model in your computer.

---

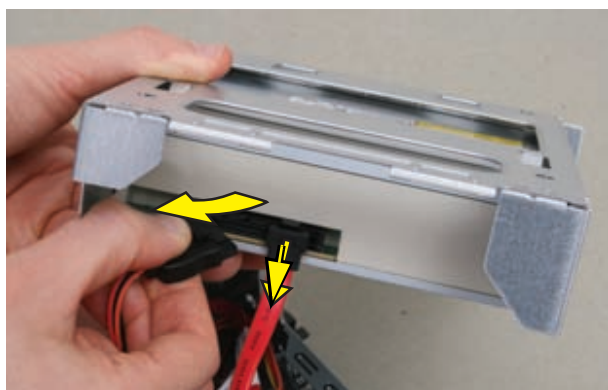
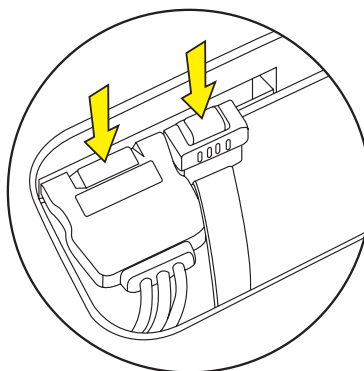

- 14 Carefully set the optical drive aside.

**15** Remove the two hard drive retention screws. Set them aside for use with the new hard drive.

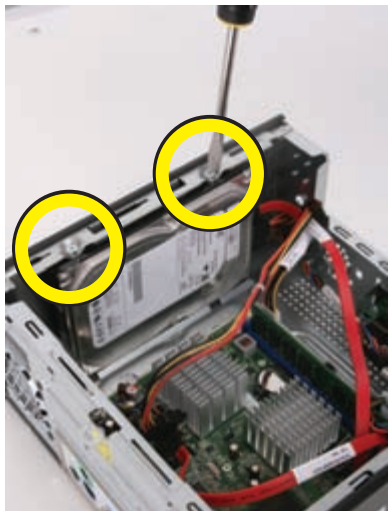

**17** Lift the hard drive straight up and out.



**18** Press the release button on the end of the power cable and the data cable while disconnecting these cables from the drive.

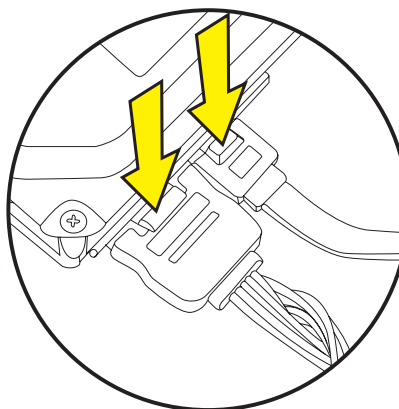

**CAUTION:** Using retention screws that are too long can damage some hard disk drives. The hard disk drive retention screws are slightly shorter than the rest of the screws. Set these screws aside for use with the replacement hard disk drive.

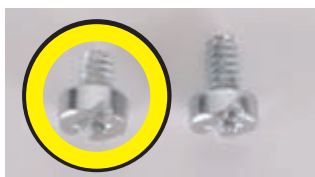

**16** Slide the hard drive to the rear of the computer until it stops. Then slide the hard drive toward the center of the computer to release it.



**REMOVAL COMPLETED**





## Replacing the Hard Disk Drive

**IMPORTANT:** The new (replacement) part may not look the same as the original part, due to different manufacturers or models. HP always provides quality parts that meet or exceed your original computer specifications.

Please do not return this part because it is different. Follow the steps in this procedure to install your new drive.

- 1 Remove the two guide screws from the old hard drive.



- 2 Install the guide screws into the new hard drive.



When you hold the drive with the label (**A**) facing up and the data and power connectors (**B**) toward you, the guide screws (**C**) will be to your left when properly installed.



- 3 Reconnect the power cable and the data cable to back of the hard drive.

**NOTE:** The SATA data cable for the hard drive is longer than the data cable for the optical drive.



- 4 Place the drive so the guide screws fit into the guide screw slots. The drive manufacturer's label should be visible when the drive is in place.



- 5 Push the hard drive back into the bay and then to the right until it locks. When the drive is properly located, the threaded holes in the drive line up with the holes in the drive bay, and the power and data cables will route properly.



- 6 Replace the hard drive retention screws and tighten them.

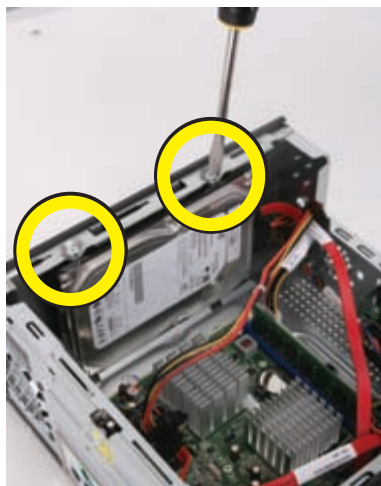

- 7 Reconnect the power cable and data cable to the optical disc drive.

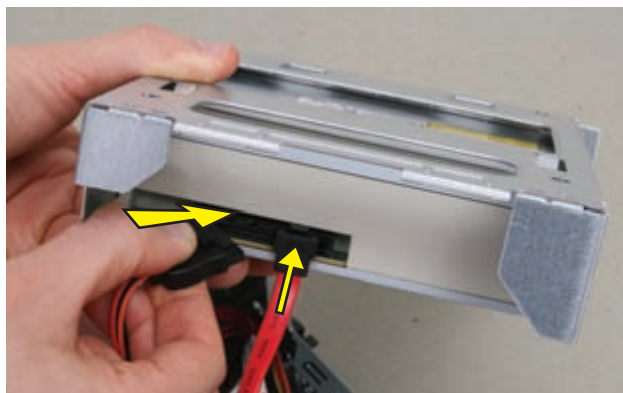

---

**NOTE:** The location of the cable connections may vary with the optical drive model in your computer.

---

**8** Insert the tabs at the rear of the optical drive and cage assembly into the slots at the rear of the computer. Then lower the front of the drive and cage assembly onto the computer.



**9** Replace the two optical drive cage screws.



**10** Stand the computer upright.

**11** Insert the tabs on the right side of the bezel into the slots on the right side of the front of the computer.



**12** Snap the left side of the bezel in place.



**13** Align the tabs on the inside edge of the left side panel with the slots in the edge of the left side of the computer case.

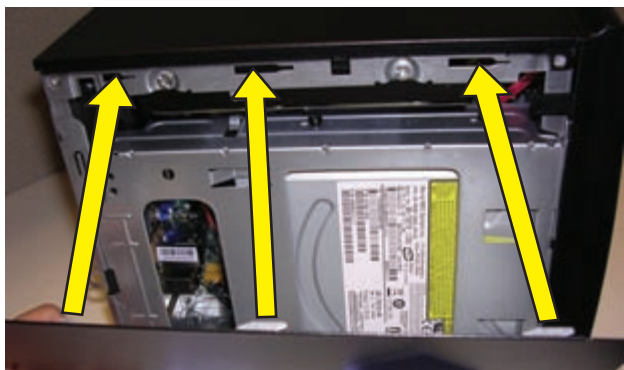

**14** Slide the left side panel into place.



**15** Replace the screws that secure the side panel to the computer.



**REPLACEMENT COMPLETED**







**COMPAQ**

## **Removing and Replacing the Optical Disc Drive**



Features may vary by model.





---

# Removing and Replacing the Optical Disc Drive



15 to 25 minutes

---

## Before You Begin

Observe the following requirements before removing and replacing an optical disc (CD/DVD) drive.

---

**IMPORTANT:** Treat an optical disc drive with care. It is easy to damage. It is sensitive to shock impact. Do not bang or drop it.

---



## Tools Needed

- Flathead screwdriver

Hewlett-Packard recommends using a magnetic tipped screwdriver. You can use a flathead screwdriver with the following screw.



---

**CAUTION:** This product contains components that are easily damaged by electrostatic discharge (ESD). To reduce the chance of ESD damage, work over a noncarpeted floor. If possible, ground yourself while touching the metal frame of the computer, prior to handling components.

---

---

## WARNING:



- 1 **Never open the cover with the power cord attached or power applied. You may damage your computer or be injured from the spinning fan blades.**
  - 2 **Avoid touching sharp edges inside the computer.**
- 

---

**NOTE:** Computer features may vary by model.

---

## Removing the Optical Disc Drive

- 1 Remove all removable media such as CDs or DVDs from the computer.
- 2 Turn off the computer using the shutdown procedure for your operating system.
- 3 Disconnect the power from the wall and from the back of the computer.

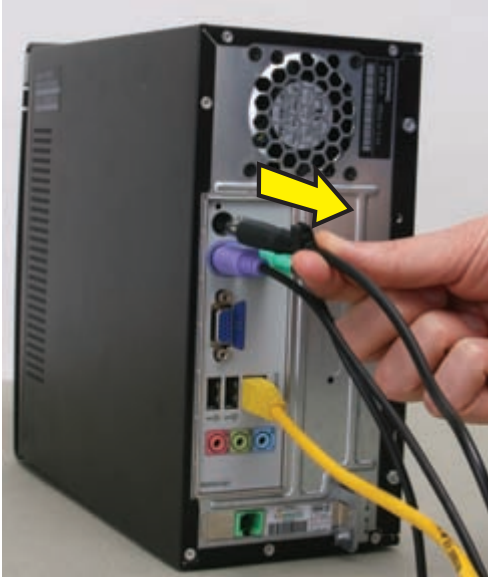

- 4 Turn off all peripheral devices (such as monitor, printer, and external drives) and disconnect them from the computer.
- 5 Disconnect the keyboard, mouse, ethernet cable, and/or phone line.
- 6 Remove the two screws that fasten the left side panel to the computer.



- 7 Slide the left side panel about 1.27 cm (0.5 in) toward the rear of the computer.



- 8 Pull the panel away from the computer and set it aside.



- 9 Release the two latching tabs on the left side of the front bezel by pulling them slightly outward. When the left side of the front bezel is released, pull it away from the computer.

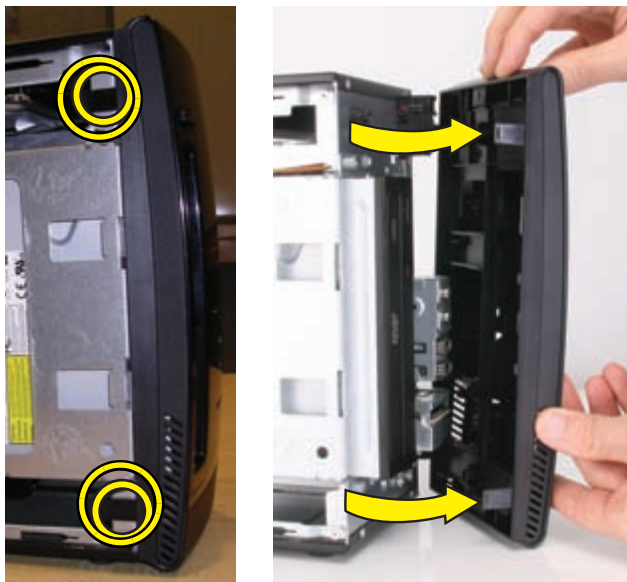

- 10 Spread a towel or soft cloth on your working surface. Then lay the computer on its side.
- 11 Remove the two screws that secure the optical drive cage to the front of the computer.



- 12 Lift the front edge of the optical drive and cage assembly (1), and then slide the tabs (2) out of the notches at the rear of the computer.

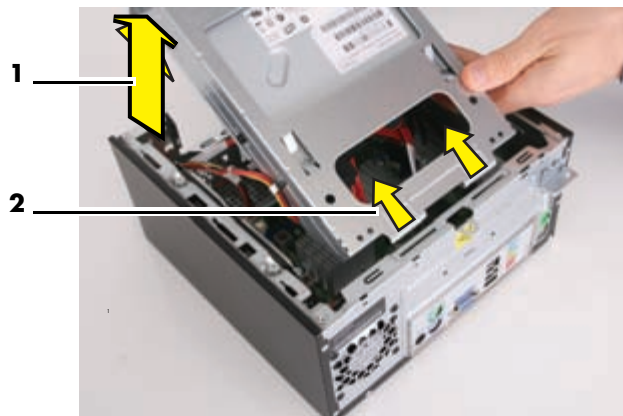

- 13 Disconnect the power cable and data cable from the back of the optical drive. Press the release button on the end of the power cable and the data cable while disconnecting these cables from the drive.

---

**NOTE:** The location of the cable connections may vary with the optical drive model in your computer.

---

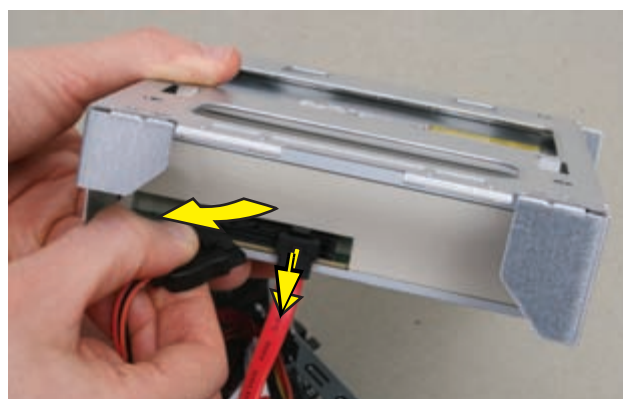
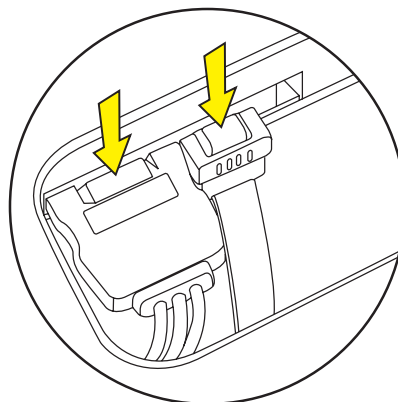

- 14** Remove the four screws (two on each side) that hold the optical drive in the drive cage.

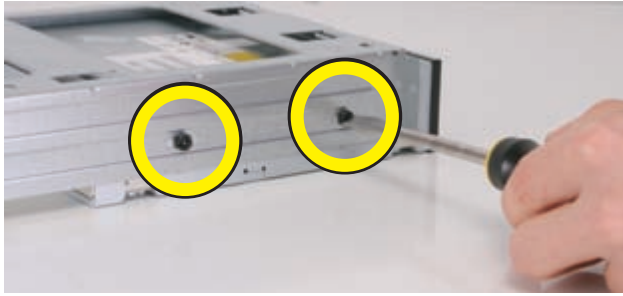

---

**NOTE:** The black, optical drive cage retention screws are metric screws.

---

- 15** Remove the drive cage from the drive.

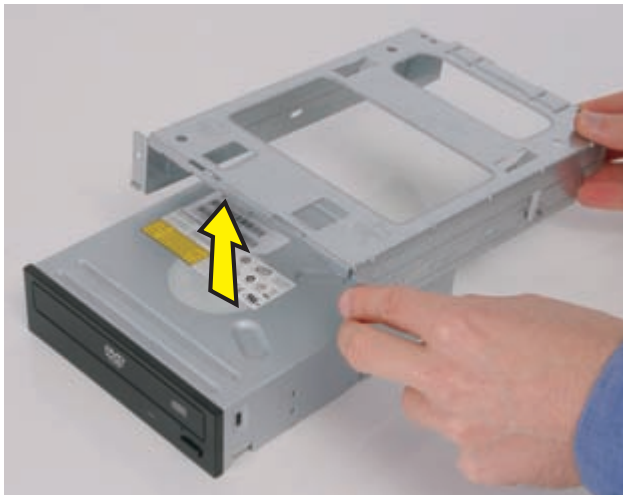

## Replacing the Optical Disc Drive

---

**IMPORTANT:** The new (replacement) part may not look the same as the original part, due to different manufacturers or models. HP always provides quality parts that meet or exceed your original computer specifications.

Please do not return this part because it is different. Follow the steps in this procedure to install your new drive.

---

- 1** Place the drive cage onto the drive.

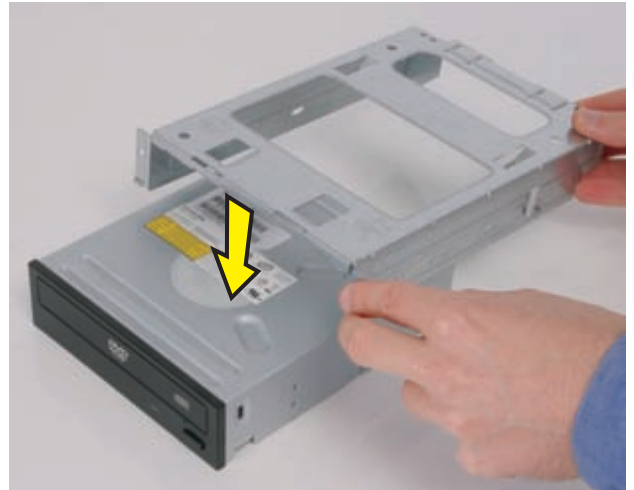

- 2** Align the holes marked "2" on the drive cage with the holes on the sides of the disc drive.



- 3 Replace the four drive cage screws.

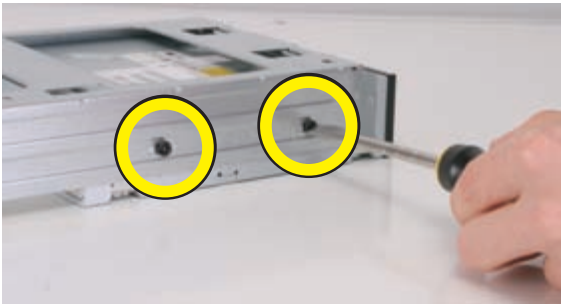

- 4 Reconnect the power cable and data cable to the optical drive.

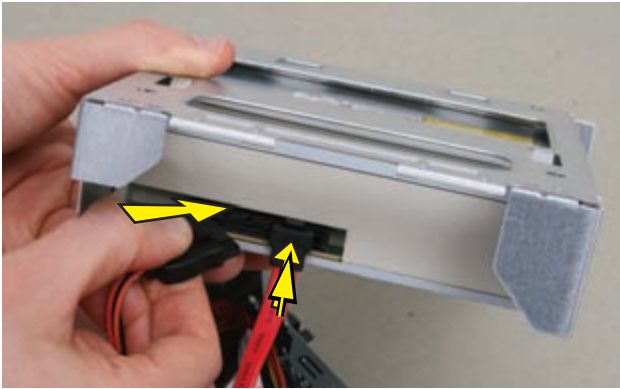

**NOTE:** The location of the cable connections may vary with the optical drive model in your computer.

- 5 Insert the tabs at the rear of the optical drive and cage assembly into the slots at the rear of the computer. Then lower the front of the drive and cage assembly onto the computer.



- 6 Replace the two optical drive cage screws.



- 7 Stand the computer upright.
- 8 Insert the tabs on the right side of the bezel into the slots on the right side of the front of the computer.



9 Snap the left side of the bezel in place.



11 Slide the left side panel into place.



10 Align the tabs on the inside edge of the left side panel with the slots in the edge of the left side of the computer case.

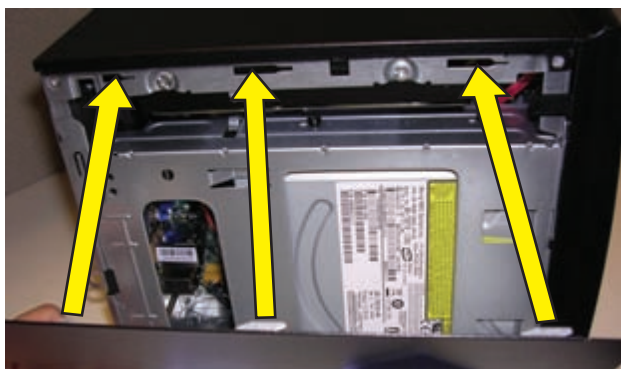

12 Replace the screws that secure the side panel to the computer.



**REPLACEMENT COMPLETED**









